

AMADO

Travel and Play Portacot



IMPORTANT

BEFORE ASSEMBLING THIS COT READ AND UNDERSTAND THE INSTRUCTIONS

Do not use mattress other than the one supplied by the manufacturer. Incorrect mattress can cause death.

Use only accessories as recommended by the manufacturers.

Make sure latches are secure.

Stop using this cot if any part of the cot is broken, torn or missing.

KEEP THESE INSTRUCTIONS IN A SAFE PLACE FOR FUTURE REFERENCE.

FURTHER INFORMATION
In Australia/New Zealand
www.veebee.com.au

© Copyright VB 2017
vs080917



Read all instructions BEFORE assembly and USE of product **IMPORTANT – KEEP INSTRUCTIONS FOR FUTURE USE**

PRODUCT REFERENCE GUIDE

Thank you for purchasing a quality VEE BEE product. Please read and follow the instructions outlined in this guide carefully. Familiarise yourself with the construction and safety features; be sure that you understand all the warnings and safety guidelines before use.

DISCLAIMER

Due to our policy of continuous product development, this product is constantly evolving. It is possible that some features or procedures outlined here have changed since this document was written. If you are unsure of any procedure shown here, please contact us via the web at info@valco.com.au to obtain the most up to date information before use. Include the batch number, which can be found on a sticker on the frame.

All pictures and diagrams herein are provided for illustration purposes only. Actual product, colour or fabric may vary. VALCO BABY reserves the right to modify or alter any specification or colour without notice or obligation to modify any product previously purchased

ICONS



IMPORTANT WARNING: Always refer to the Warnings page when you see this symbol



NEVER LEAVE YOUR CHILD UNATTENDED



TO AVOID INJURY ENSURE THAT YOUR CHILD IS KEPT AWAY WHEN UNFOLDING AND FOLDING THIS PRODUCT.



ENSURE THAT ALL LOCKING MECHANISMS ARE ENGAGED BEFORE USE

veebee.com.au

PARTS/OVERVIEW

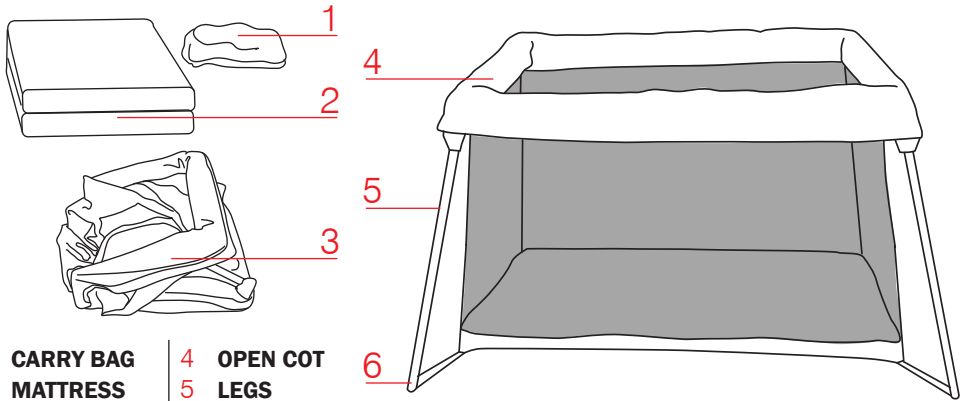

- | | | | |
|---|------------|---|----------|
| 1 | CARRY BAG | 4 | OPEN COT |
| 2 | MATTRESS | 5 | LEGS |
| 3 | FOLDED COT | 6 | FEET |

TO OPEN

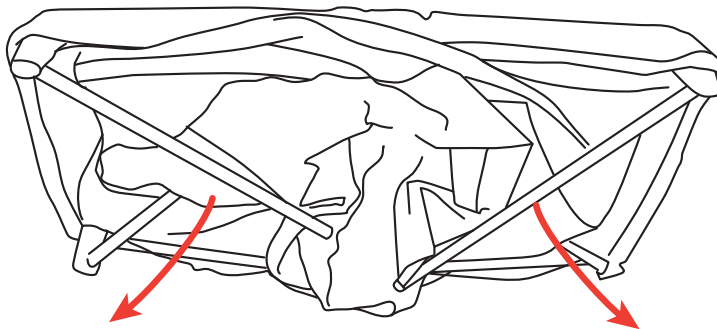
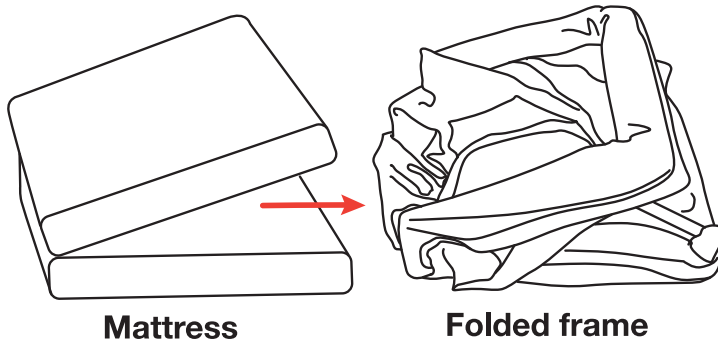

With legs on the underside, lift and open the frame

LOCK LEGS

Unfold leg until buttons 'pop' up and securely lock leg in place

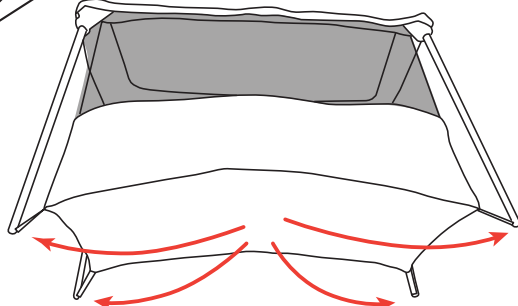
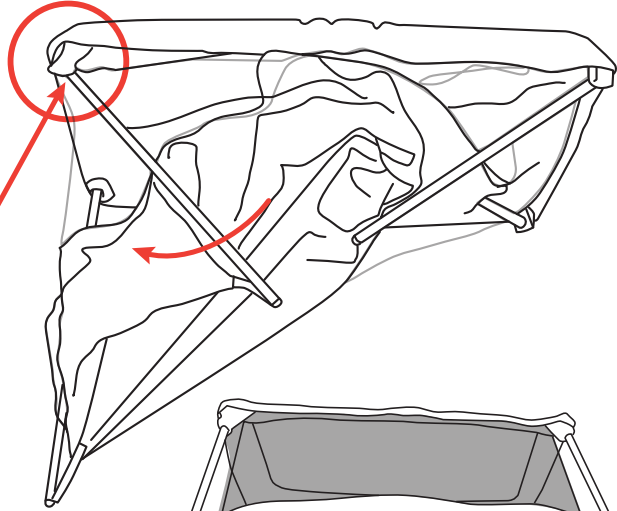
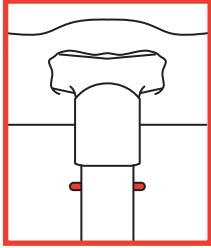

Open and lock all legs

MATTRESS

Open mattress

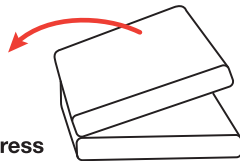

Place mattress into the Amado. Thread Velcro tabs through buttonholes in floor of unit and secure underneath

Pull each leg fully locked and extended outward to ensure that the Amado is fully deployed with maximum stability.

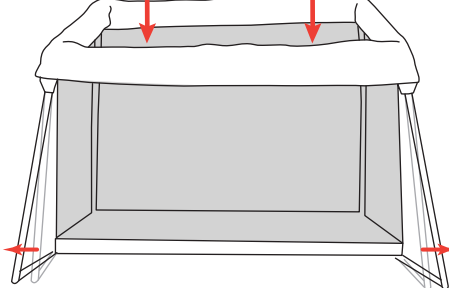

FOLD

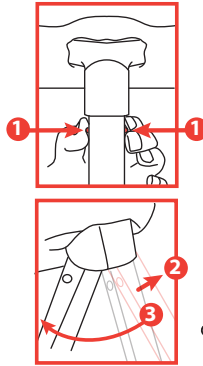
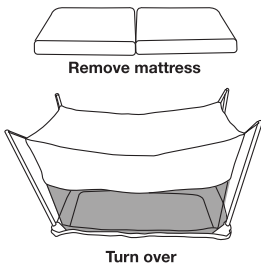

To fold leg;

1. Squeeze buttons on either side of leg simultaneously.
2. Gently ease leg back slightly towards you to release lock.
3. Fold leg down to centre of unit

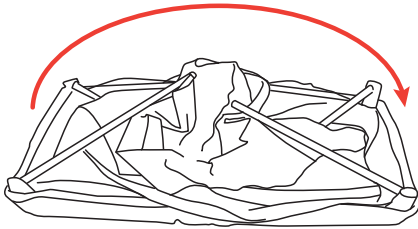
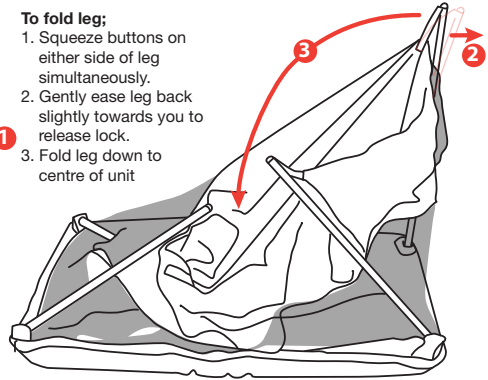

Folded frame

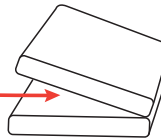

Mattress

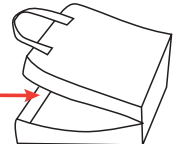

Carry bag



CARE

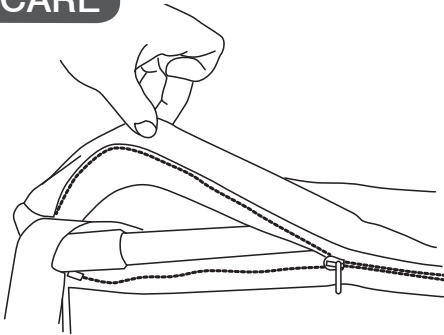

The fabric of the Amado Portacot is fully removable for washing. Simply locate the zipper under the top padding on each side, unzip and remove the fabric. See care instructions for washing detail. Once cleaned, reverse the procedure to replace the fabric.

The mattress cover is fully removable and washable.

CARE INSTRUCTIONS:

 Hand wash only. Close zippers before washing. Warm rinse. Dry in shade. Wash dark colours separately.

 Warm iron.

 Do not bleach.

 Do not dry clean.

 Do not tumble dry.

www.veebee.com.au



WARNING: TO AVOID INJURY OR DEATH



- ⚠ FOLLOW THE MANUFACTURER'S INSTRUCTIONS.**
- ⚠ DO NOT LEAVE CHILDREN UNATTENDED.**
- ⚠ KEEP THE AMADO CLEAR OF TRAILING CABLES AND HANGING CORDS.**
- ⚠ THE THICKNESS OF THE MATTRESS HAS BEEN SPECIFIED TO ENSURE THAT THE DISTANCE FROM THE TOP OF THE MATTRESS TO THE TOP OF THE LOWEST SIDE OR END WILL ALWAYS BE AT LEAST 500MM. THIS REDUCES THE RISK OF CHILDREN FALLING OUT OF THE COT.**

FAILURE TO FOLLOW THESE WARNINGS AND THE INSTRUCTIONS COULD RESULT IN SERIOUS INJURY OR DEATH.

- THE PRODUCT, INCLUDING SIDE RAILS MUST BE FULLY ERECTED PRIOR TO USE.
- DURING ASSEMBLY ENSURE THAT THE COT IS CORRECTLY ASSEMBLED, CORRECT AND SAFE FOR USE
- REGULARY CHECK THAT ALL LATCHES/FASTENINGS ARE FULLY TIGHTENED AND SECURE.
- NEVER LEAVE ANYTHING IN COT (SUCH AS TOYS) THAT MAY PROVIDE A FOOTHOLD OR COULD SERVE AS STEPS FOR CLIMBING OUT.
- KEEP ALL MEDICATION AND SMALL ITEMS THAT A CHILD MAY CHOKE ON AWAY FROM COT.
- NEVER USE COT IF PADDED RIM MATERIAL HAS BEEN TORN OR BITEN THROUGH.
- NEVER USE THIS PRODUCT IF THERE ARE ANY LOOSE OR MISSING FASTENERS, LOOSE JOINTS, BROKEN PARTS, OR TORN MESH/FABRIC. CHECK BEFORE ASSEMBLY AND PERIODICALLY DURING USE. CONTACT VALCO BABY FOR REPLACEMENT PARTS. NEVER SUBSTITUTE PARTS.
- STRINGS CAN CAUSE STRANGULATION! NEVER PLACE ITEMS WITH A STRING AROUND A CHILD'S NECK SUCH AS HOOD STRINGS OR PACIFIER CORDS. NEVER SUSPEND STRINGS OVER PRODUCT OR ATTACH STRINGS TO TOYS.
- DISCONTINUE USE OF THE PRODUCT WHEN CHILD IS ABLE TO CLIMB OUT OR REACHES THE HEIGHT OF 35 IN. (890MM)

-
- **CHILD CAN BECOME ENTRAPPED AND DIE WHEN IMPROVISED NETTING OR COVERS ARE PLACED ON TOP OF PRODUCT. NEVER ADD SUCH ITEMS TO CONFINE CHILD IN PRODUCT.**
 - **NEVER PLACE PRODUCT NEAR A WINDOW WHERE CORDS FROM BLINDS OR DRAPES CAN STRANGLE A CHILD.**
 - **USE ONLY MATTRESS/PAD PROVIDED BY MANUFACTURER WHICH MUST BE AT LEAST 550MM WIDE, 970MM LONG AND NO MORE THAN 30MM THICK.**
 - **ALWAYS PROVIDE THE SUPERVISION NECESSARY FOR THE CONTINUED SAFETY OF YOUR CHILD. WHEN USED FOR PLAYING, NEVER LEAVE CHILD UNATTENDED.**
 - **TO REDUCE THE RISK OF SIDS, PEDIATRICIANS RECOMMEND HEALTHY INFANTS BE PLACED ON THEIR BACK TO SLEEP, UNLESS OTHERWISE ADVISED BY YOUR PHYSICIAN.**
 - **NEVER USE PLASTIC SHIPPING BAGS OR OTHER PLASTIC FILM AS MATTRESS COVERS AS THEY ARE NOT SOLD OR INTENDED FOR THAT PURPOSE. THEY CAN CAUSE SUFFOCATION.**
 - **NEVER USE A WATER MATTRESS WITH THIS PRODUCT.**
 - **DO NOT PLACE YOUR AMADO PORTACOT ANYWHERE NEAR HAZARDS SUCH AS OPEN FIRES OR OTHER SIGNIFICANT SOURCES OF HEAT SUCH AS RADIATORS, BARBECUES, STOVES, ETC.**
 - **DO NOT MOVE THE AMADO PORTACOT WITH A CHILD INSIDE.**
 - **WHEN USING A FITTED SHEET BE SURE TO CHECK THAT IT IS FITTED TIGHTLY AND DOES NOT INTERFERE WITH THE MEASUREMENT OUTLINED ABOVE. (SHEET ONLY AVAILABLE IN USA)**
 - **THIS PRODUCT IS INTENDED FOR DOMESTIC USE ONLY. IT IS NOT INTENDED FOR COMMERCIAL USE**
 - **WARNING: IF REFINISHING, USE A NONTOXIC FINISH SPECIFIED FOR CHILDREN'S PRODUCTS.**

CARE AND MAINTENANCE

- **Continued and extended exposure to sunlight and the elements can change the colours of many materials. To avoid fading, always cover and store in a shaded area.**
- **DO NOT use any bleach based products to clean the AMADO Portacot.**
- **The AMADO Portacot fabrics can be removed and washed. See Care Instructions.**
- **To prevent mould or mildew always allow fabrics to air and dry COMPLETELY before storing.**
- **Always store in a well ventilated area.**

WARNING MATTRESS SIZE

- USE ONLY THE MATTRESS SUPPLIED BY THE MANUFACTURER, INCORRECT MATTRESSES CAN CAUSE DEATH.
-

WARNING STRANGULATION HAZARD

- YOUR CHILD CAN BECOME ENTRAPPED AND DIE WHEN IMPROVISED NETTING OR COVERS ARE PLACED ON TOP OF PRODUCT. NEVER ADD SUCH ITEMS TO CONFINE CHILD IN PRODUCT.
-

WARNING SUFFOCATION HAZARD *INFANTS CAN SUFFOCATE*

- IN GAPS BETWEEN A MATTRESS TOO SMALL OR TOO THICK AND PRODUCT SIDES.
 - ON SOFT BEDDING
 - NEVER ADD A MATTRESS, PILLOW, COMFORTER OR PADDING.
- USE ONLY THE FITTED MATTRESS COVER PROVIDED WHICH HAS BEEN SPECIFICALLY DESIGNED TO FIT THE DIMENSIONS OF THE MATTRESS